



PMI RESEARCH & DEVELOPMENT

# A modified Cambridge filter holder with extraction equipment and methodology to more accurately quantify water in high water content aerosols

**2013 CORESTA Joint Study Groups Meeting  
Smoke Science & Product Technology**

30<sup>th</sup> September 2013

GHOSH D.\*; JEANNET C.

Philip Morris International, Research & Development, Quai Jeanrenaud 5, 2000 Neuchâtel, Switzerland

\*E-mail: david.ghosh@pmi.com

# Introduction

Philip Morris International is developing products with the potential to reduce the risk of smoking-related diseases by heating tobacco and avoiding combustion. The resulting aerosol has a less complex chemical composition and contains approx. 20 times more water than conventional cigarette smoke under the ISO smoking regimen.



It has been determined that the trapping and extraction procedure used for conventional cigarettes, defined in the International Standard ISO 4387, is not suitable for the high water content present in such heated tobacco aerosols.

# Challenge

Aerosol from PMI heated tobacco product contains 20 times more water than conventional cigarettes smoke under the ISO smoking regimen.

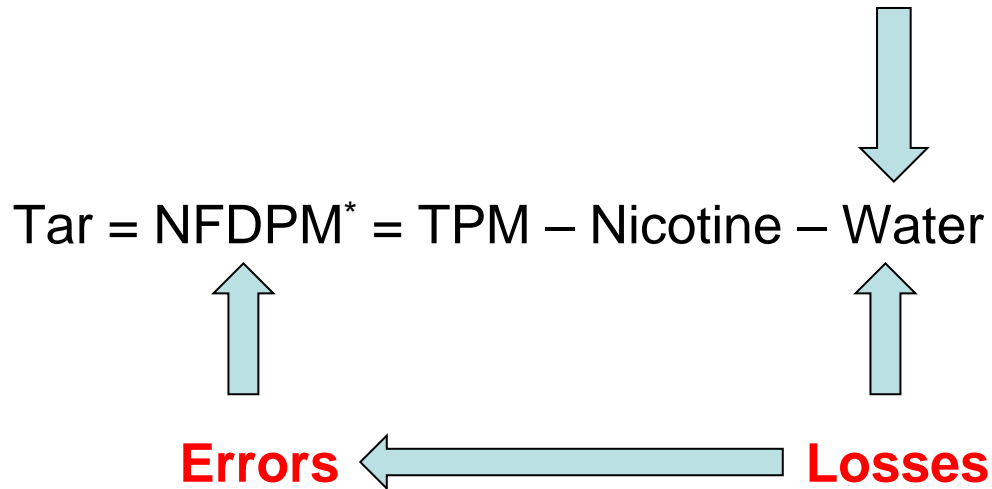

# Water losses with standard ISO equipment

**Water losses** can arise due to opening of the Cambridge filter pad holder as well as the manual removal of the filter, and because the plastic housing of the filter may adsorb water. This results in inaccurate values for the water content, and erroneous and overestimated values for NFDPM.



Solution

Develop a **metallic** Cambridge filter pad holder which allows to extract the TPM **without** opening the filter holder = ***in situ* extraction**

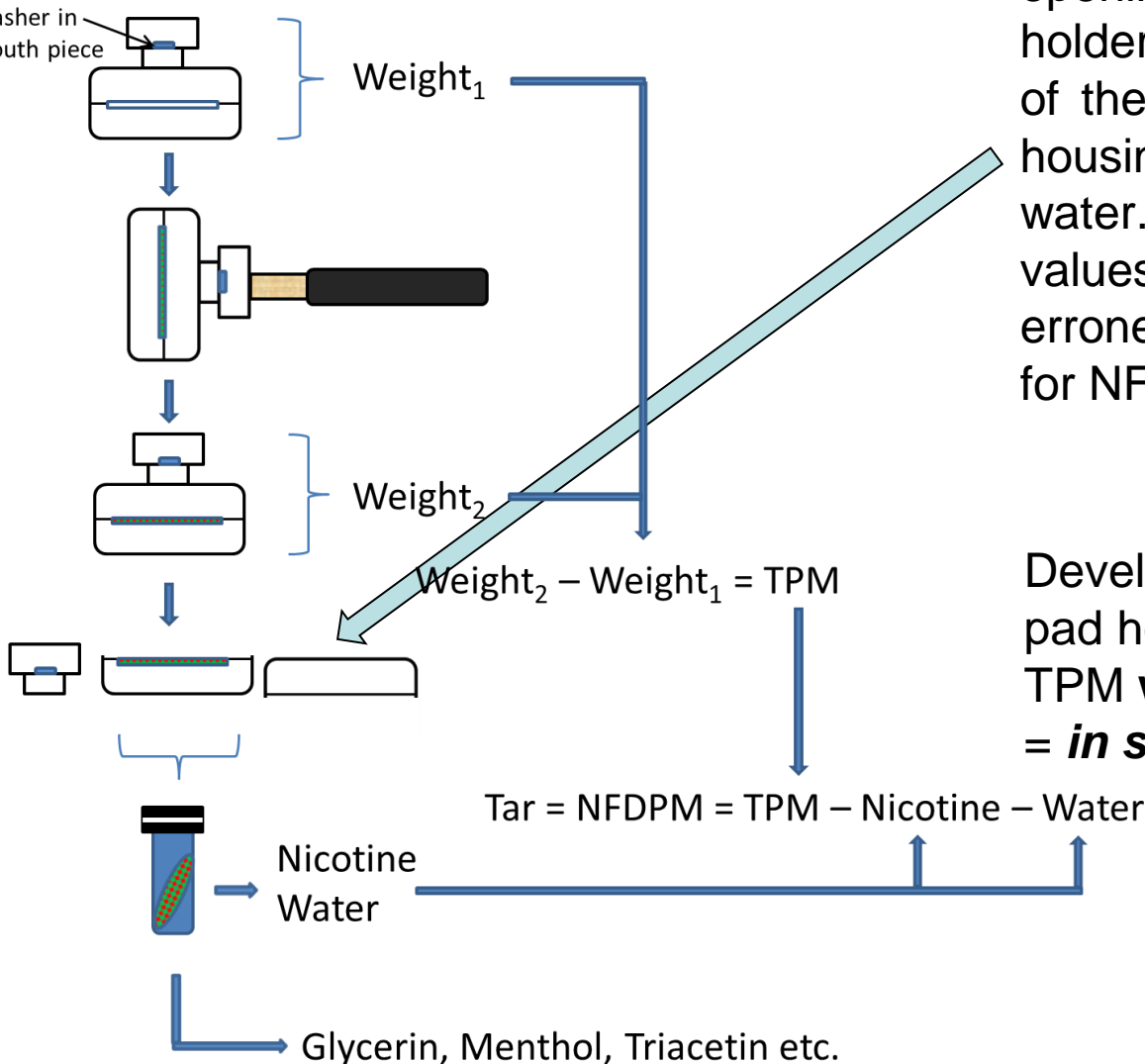

# The *in situ* equipment and methodology

Aluminum alloy with a Nickel surface treatment of 10  $\mu\text{m}$

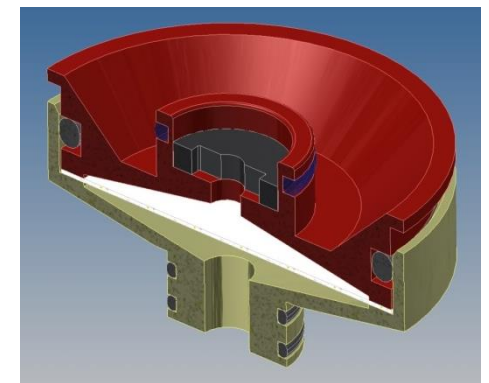
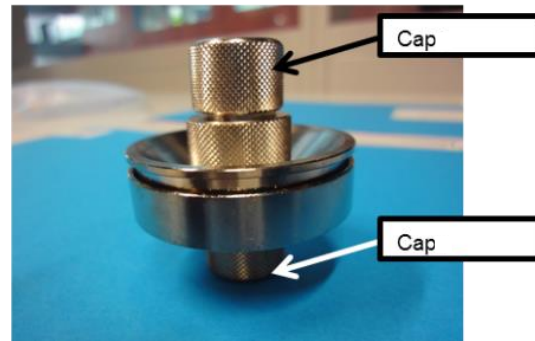
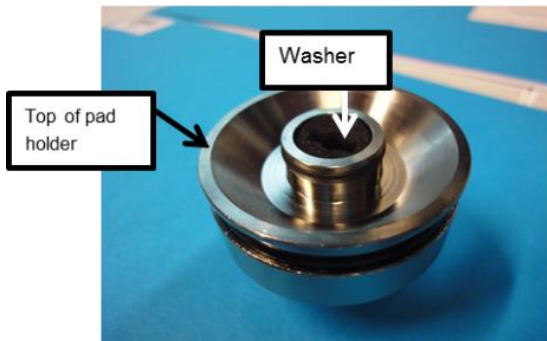
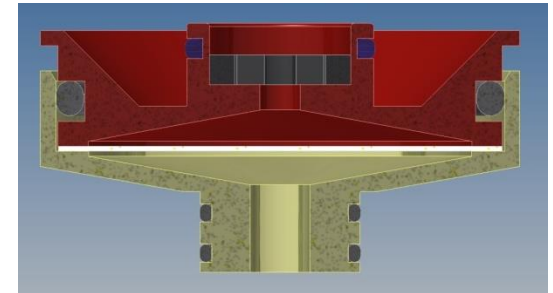
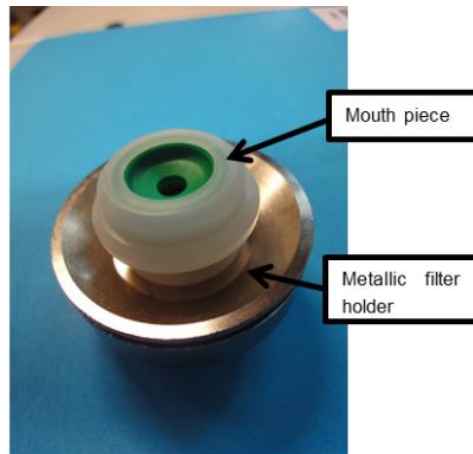

# The *in situ* equipment and methodology

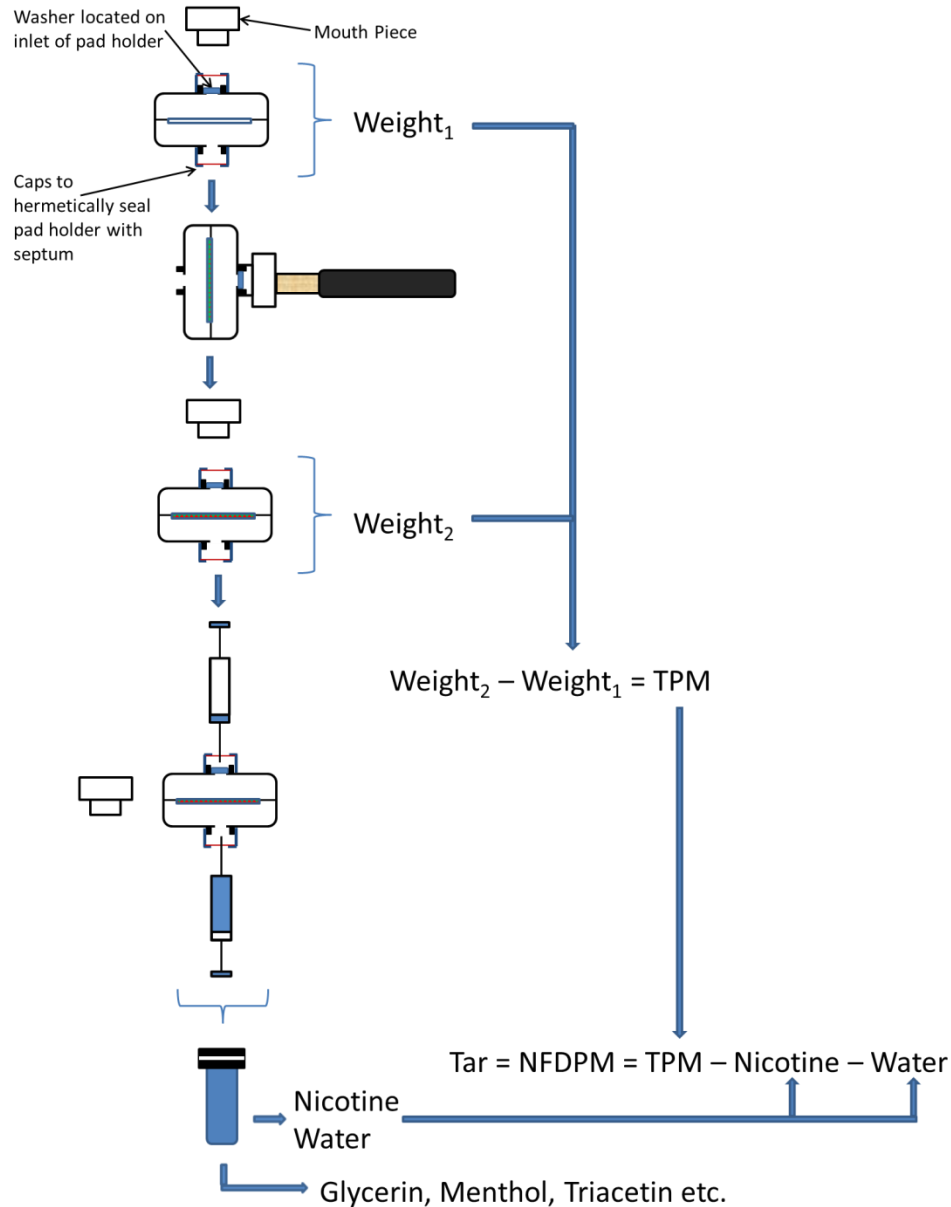

# The *in situ* equipment and methodology

Continuous  
flushing for  
30 minutes

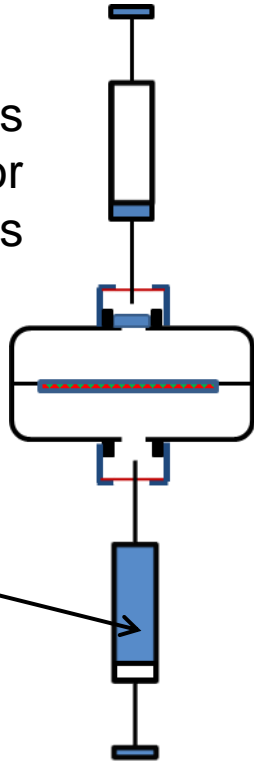

10ml of  
Isopropanol



Empty Syringe

Syringe filled with  
10 ml Isopropanol

# Method tested and validated

- *In situ* vs. standard ISO equipment
- Method tested & validated with three test items
  - PMI heated tobacco product
  - 3R4F reference cigarette
  - PMI conventional cigarette
- Method tested & validated with two smoking regimens
  - ISO smoking regimen
  - HCl smoking regimen



# PMI heated tobacco product

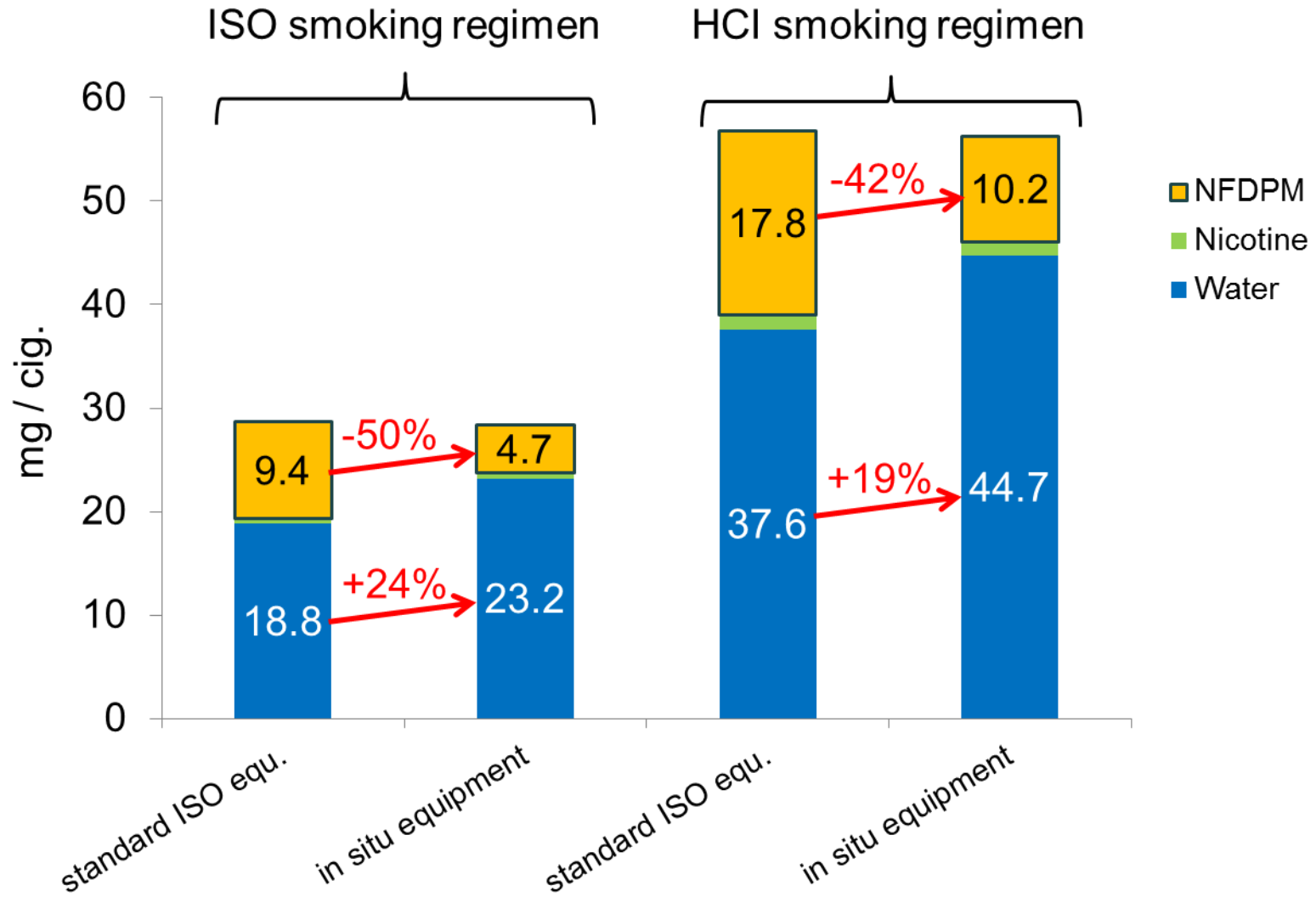

# 3R4F reference cigarette

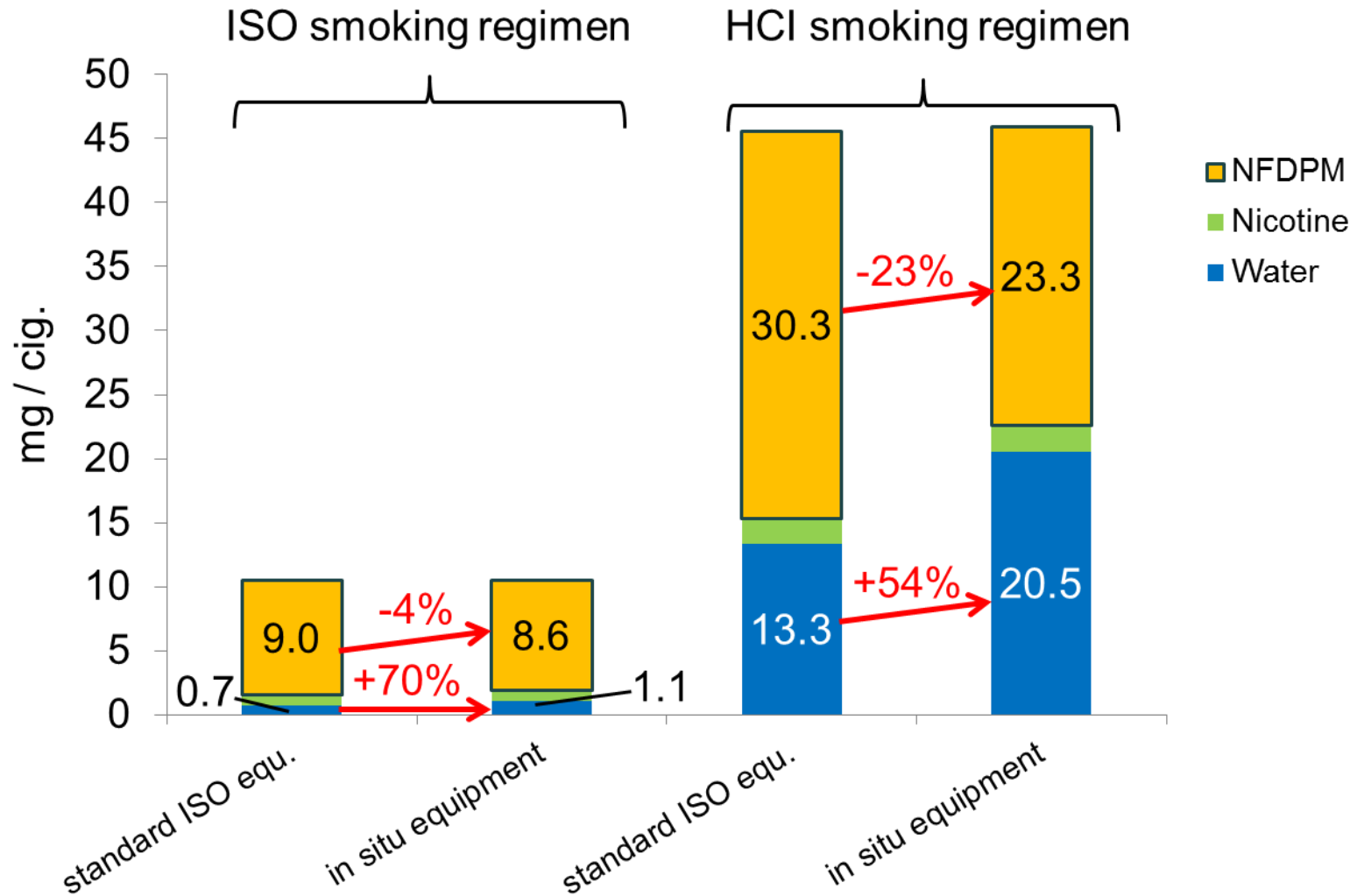

# PMI conventional cigarette

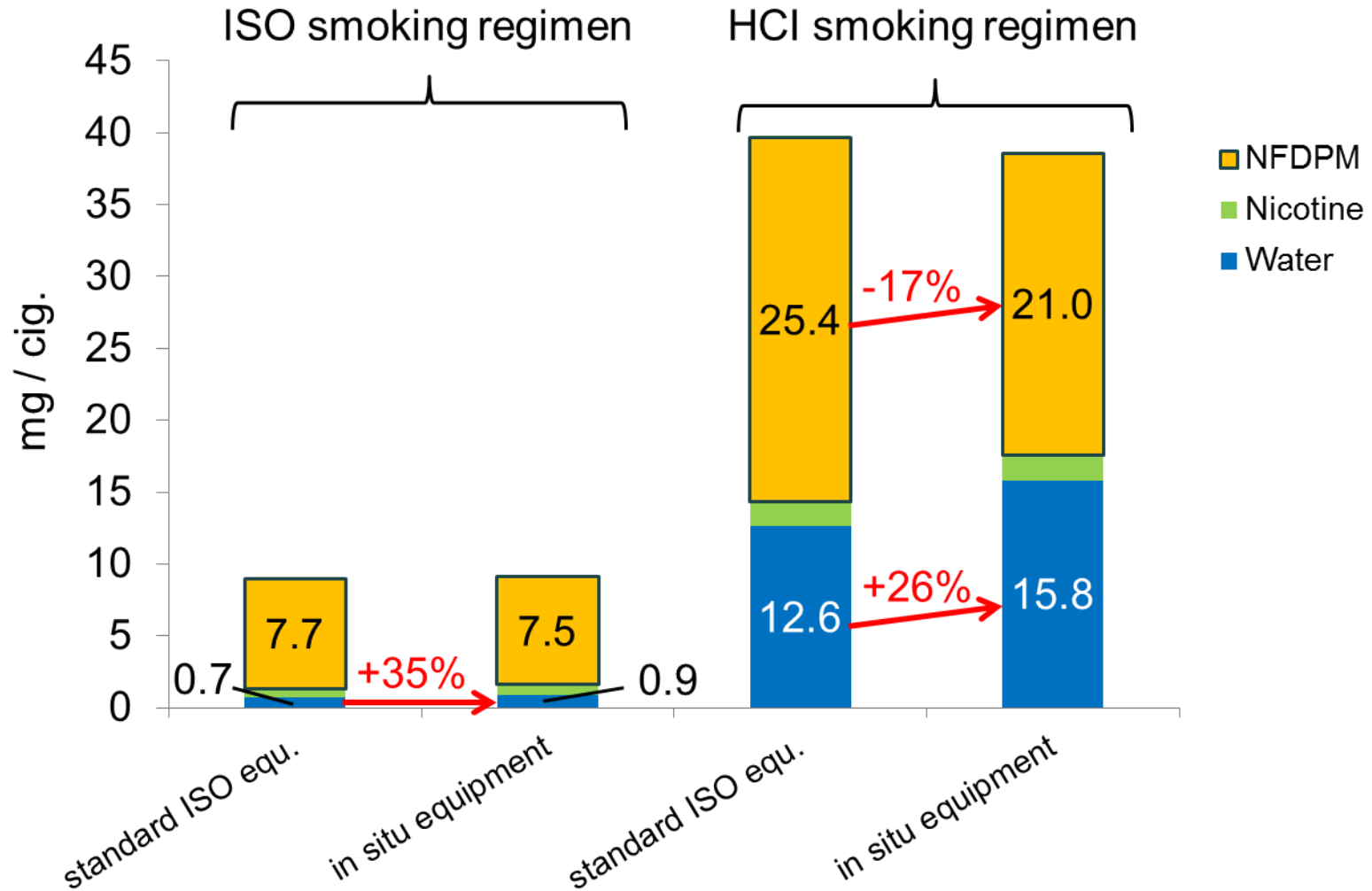

# Statistical summary for water and NFDPM

	ISO smoking regimen		HCI smoking regimen		
	Trueness (difference in mean values)	Precision (difference in variances)	Trueness (difference in mean values)	Precision (difference in variances)	
PMI heated tobacco product	Water	Significant differences: <i>in situ</i> recovers more water	No significant differences	Significant differences: <i>in situ</i> recovers more water	No significant differences
	NFDPM	Significant differences: <i>in situ</i> results in less NFDPM	No significant differences	Significant differences: <i>in situ</i> results in less NFDPM	No significant differences
3R4F reference cigarette	Water	Significant differences: <i>in situ</i> recovers more water	No significant differences	Significant differences: <i>in situ</i> recovers more water	No significant differences
	NFDPM	Significant differences: <i>in situ</i> results in less NFDPM	No significant differences	Significant differences: <i>in situ</i> results in less NFDPM	No significant differences
PMI conventional cigarette	Water	Significant differences: <i>in situ</i> recovers more water	No significant differences	Significant differences: <i>in situ</i> recovers more water	No significant differences
	NFDPM	No significant differences	No significant differences	Significant differences: <i>in situ</i> results in less NFDPM	No significant differences

# *In situ* extraction vs. standard ISO equipment

Water losses lead to overestimated NFDPM values.

$$\text{NFDPM} = \text{TPM} - \text{Nicotine} - \text{Water}$$

standard ISO equipment

*in situ* extraction

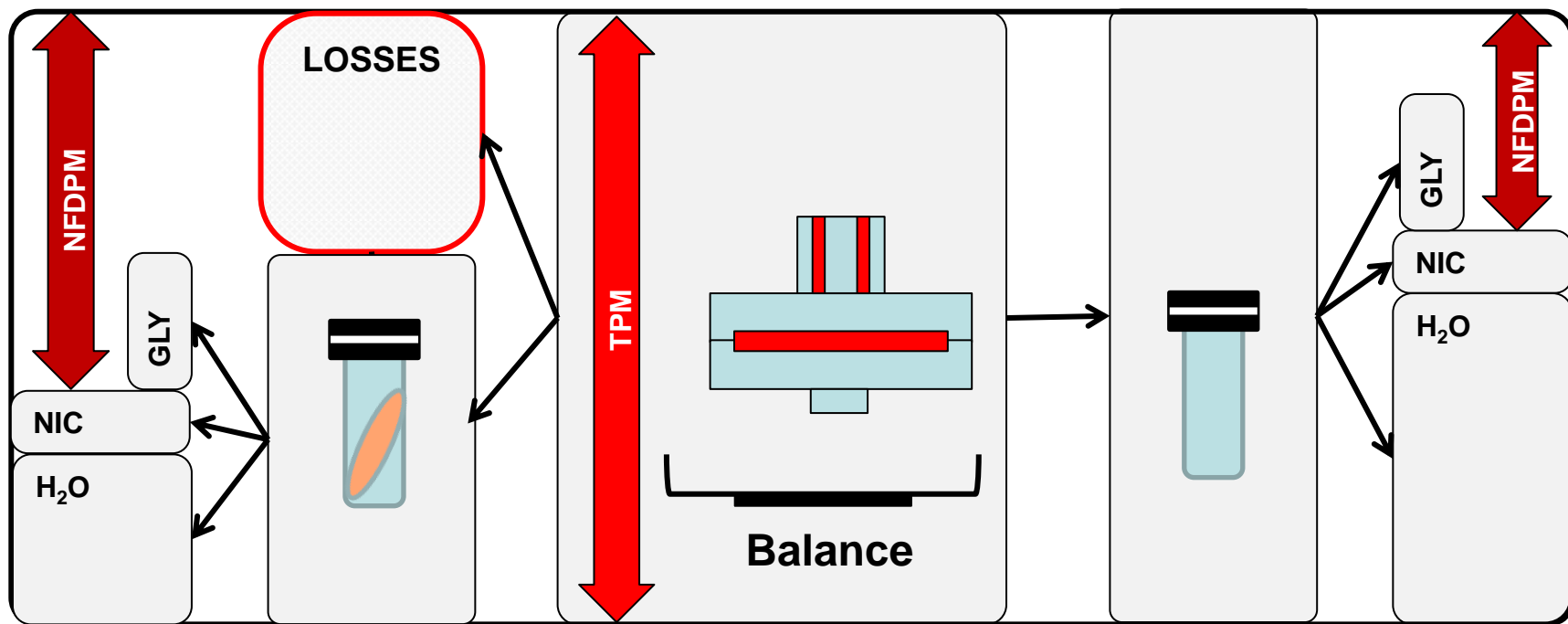

# Summary

- Standard ISO equipment is not suited for high water content aerosols as it shows incomplete water recovery. The resulting NFDPM values are falsely too high.
- *In situ* extraction methodology shows a significantly more complete water recovery.
- *In situ* methodology shows a significantly more complete water recovery and results in lower NFDPM values not by chance but because the *in situ* methodology was designed to eliminate sources of water losses inherent in the standard ISO equipment.
- We currently use and recommend to use the *in situ* extraction equipment and methodology to determine TPM, CO, nicotine, water, glycerin and NFDPM of the aerosol generated by our PMI heated tobacco product.



Thank you.

Discussion & Questions